

PTM-48A

PHOTOSYNTHESIS MONITOR

*Automatic four-channel open-type system
for monitoring CO₂ exchange and transpiration of leaves*

User's Guide



2010

Introduction

The PTM-48A Photosynthesis Monitor is a truly state-of-the-art system for long-term automatic recording all but most measurable physiological characteristics of intact plants.







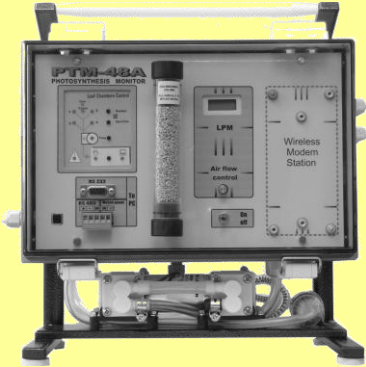
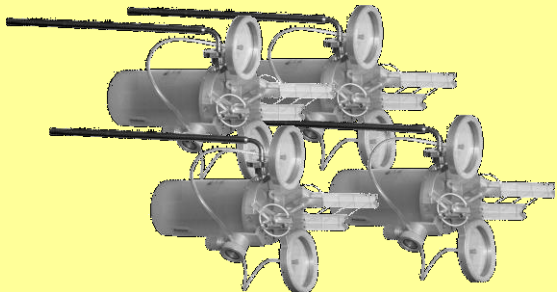

The Monitor has many optional accessories for providing various measurements.

The introductory table below may help a user to comprehend capabilities of the basic PTM-48A set and also to choose appropriate parts and accessories in order to meet his/her demands to a greater extent.

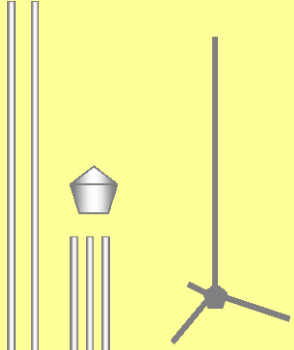
Measurement	Basic set	Extensions
CO ₂ exchange of leaves (Photosynthesis and Respiration) – Four LC-4B Leaf Chambers	Yes	
Transpiration of leaves – Four LC-4B Leaf Chambers	Yes	
CO ₂ concentration in the air – 4 channels. Measured separately near every Leaf Chamber	Yes	
Photosynthetically active radiation	Yes	
Air Temperature (in RTH-48 Meter)	Yes	
Air Relative Humidity (in RTH-48 Meter)	Yes	
Air Vapor Pressure Deficit	Yes	
Dew Point Temperature	Yes	
Wetness (in RTH-48 Meter)	Yes	
Atmospheric pressure	Yes	
Stomatal conductance	-	Optional LT-LC Leaf Temperature Sensor (Page 15) mounted inside the LC-4B Leaf Chamber
Photorespiration and dark respiration	-	Optional LC-4D Leaf Chamber (Page 16).
Leaf Temperature Sensor (contact)	-	
Leaf Temperature Sensor (Infrared)	-	
Sap Flow sensors (two models)	-	
Stem Micro-variation Sensors (3 models)	-	Optional analog sensors. May be connected to any of eight available analog inputs of the PTM-48A Photosynthesis Monitor. See Page 8 for more details.
Fruit Growth sensors (four models)	-	
Auxanometer	-	
Pyranometer	-	
Quantum sensor	-	
Soil Moisture Sensor	-	
Soil Temperature Sensor	-	
Soil Moisture, EC and Temperature sensor	-	Optional Integrated digital sensor connected to the RTH-48 Meter.

What you find in the pack

Basic content of the package

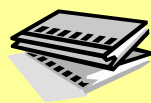
<p>PTM-48A SYSTEM CONSOLE</p> 		<p>LC-4B LEAF CHAMBER (4 pcs.)</p> 	
<p>RTH-48 METER</p> 	<p>12 VDC POWER ADAPTER (90-260 VAC, 50-60 Hz)</p> 	<p>STAINLESS STEEL TRIPOD with mounting accessories (1.5 m height, 2 pcs)</p> 	
<p>HOLDER FOR LEAF CHAMBER (4 pcs.)</p> 	<p>4-m PVC TWIN HOSE (4 pcs.)</p> 		
<p>RS232 COMMUNICATION CABLE FOR PC</p> 	<p>DOCUMENTATION and SOFTWARE SETUP CD</p> 		
<p>CO₂ ABSORBER</p> 	<p>SPARE AIR FILTER</p> 	<p>USER'S GUIDE</p> 	

In addition to the basic parts shown above, the package may include optional sensors and communication accessories, all according to a particular order.

Overview

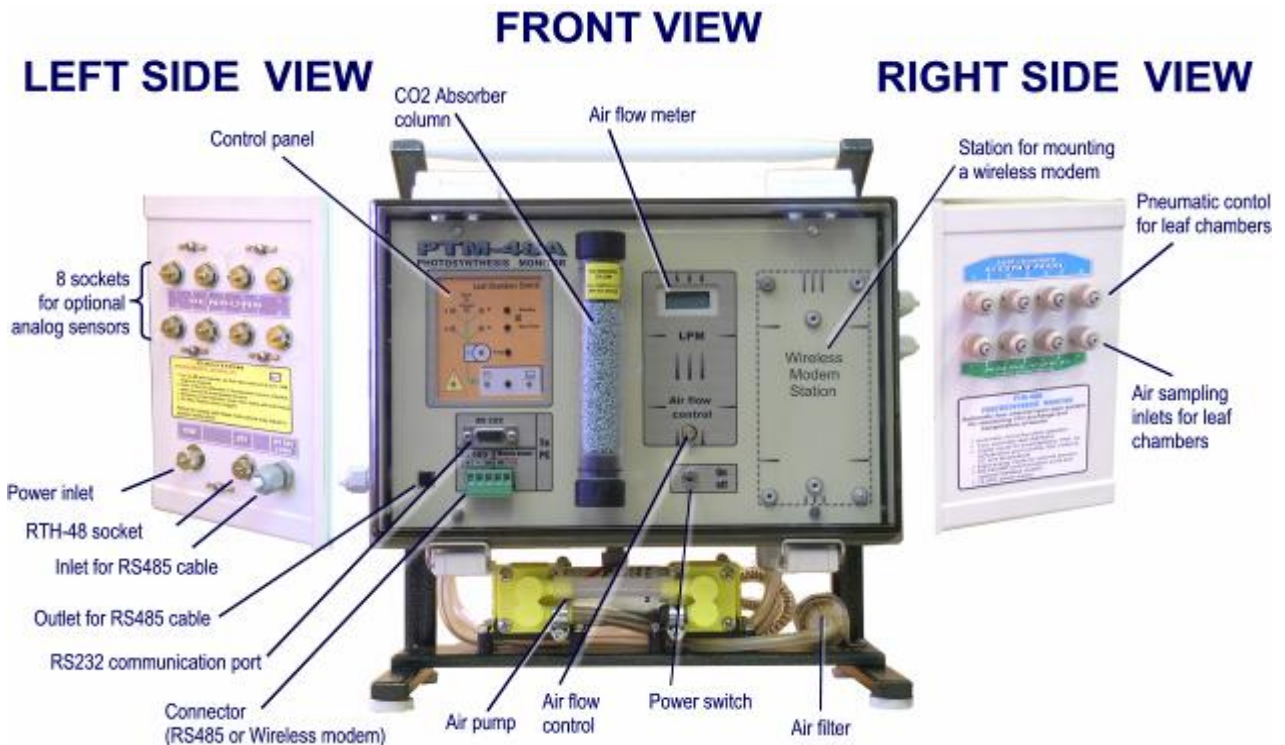

CONTROL PANEL

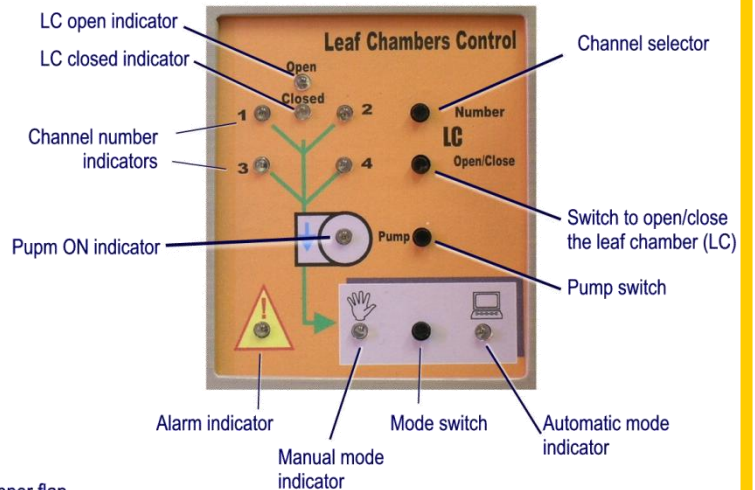

LC-4B LEAF CHAMBER

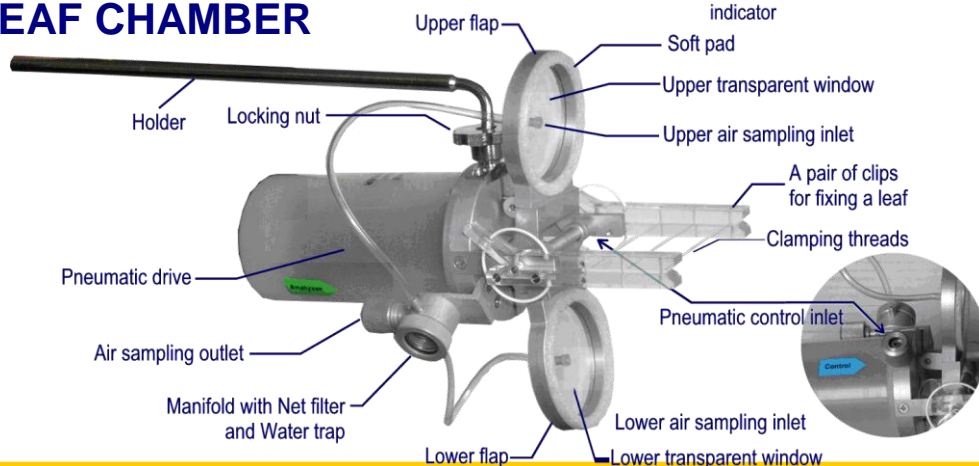

Connections

Pneumatic Connection

Connect the desired quantity of leaf chambers (1 to 4) to air sampling and pneumatic control inlets by using the standard twin 4-meter PVC hoses. Follow the instructions below.



Choose an inlet for connection. All air-sampling and control inlets are located at the right side of the PTM-48A system console. Sampling inlets are green, and control ones are blue. To avoid mismatching, both sampling and control PVC hoses are marked with the appropriate color and also numbered.

Unscrew the ring nut.

Put the end of PVC hose through the ring nut.

Connect the hose to the air-sampling inlet and tighten the ring nut.

Connect the control end of the hose to the appropriate control inlet.



Locate an opposite end of the hose for connecting to a leaf chamber.

Put the ends of PVC hose through the ring nuts

Connect sampling (Analyzer) and control hoses to the appropriate inlets of the leaf chamber.



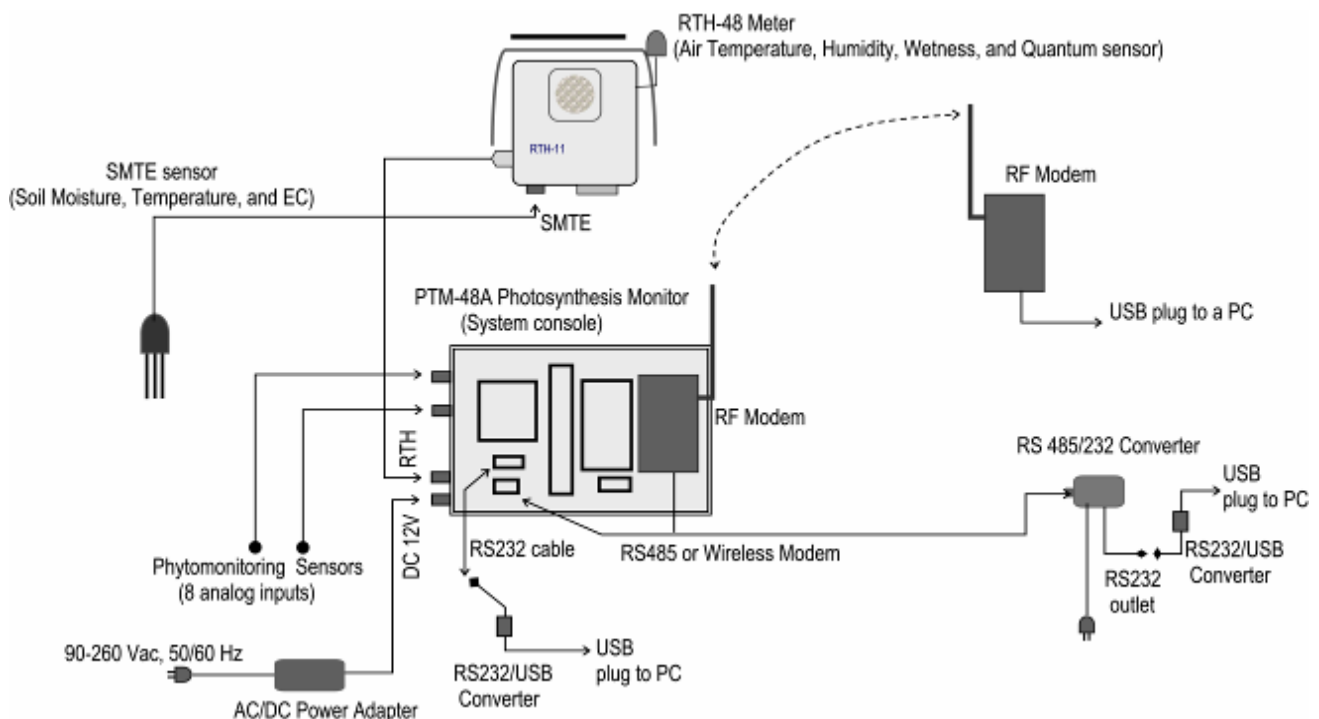

Tighten the ring nuts.

Electrical Connection



Installation of Leaf chambers

Mount a leaf chamber on a tripod as shown below:

<p>1</p>  <p>Assemble the tripod. Mount the angle clip to the tripod and tighten the locking bolt.</p>	<p>2</p>  <p>Attach the holder to the leaf chamber and slightly tighten its locking nut.</p>	<p>3</p>  <p>Insert the holder into the angle clip and tighten the appropriate locking bolt.</p>	<p>4</p>  <p>Adjust position of the chamber. Open the leaf chamber clips and secure the leaf in the desired position. Then, fasten all locking bolts and nuts.</p>
--	--	---	--

Positions of a leaf chamber flaps in operation are shown below:



Correct orientation of the leaf chamber in the Northern hemisphere is shown in the picture below. In the Southern hemisphere, orientation must be opposite.

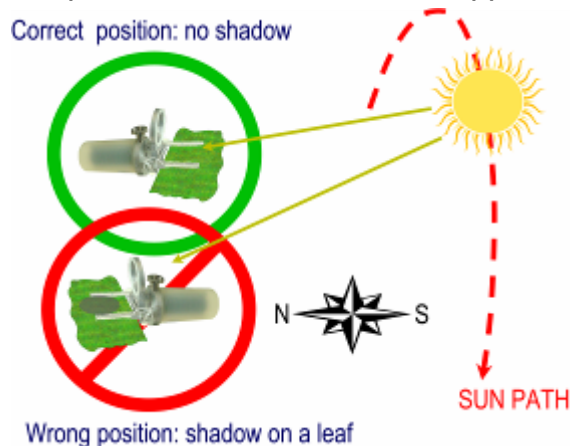

Operation

Automatic and manual mode

Manual Mode

Manual mode is used only for testing and tuning the system. In manual mode, the system may be controlled by using the Control panel, located at the front panel of the System console (see Page 5).

Automatic Mode

This is the main mode of operation. In automatic mode, the system operates according to settings specified in the current Project descriptor. The data logging session can be initialized only via computer interface (Terminal emulator). Then, the system operates automatically and does not require permanent connection to the computer. After occasional power interruption, the system resumes operation in previous mode.

Optional Sensors

The PTM-48A Photosynthesis Monitor has 8 analog inputs for optional sensors and one digital input for connecting the SMTE sensor to the RTH-48 Meter.

	Sensor Description	Measurement Range	Notes
	SD-5P Stem Microvariation Sensor	0 to 5 mm	For 5 to 25 mm stem dia.
	SD-6P Trunk Microvariation Sensor	0 to 5 mm	For 2 to 7 cm stem dia.
	DE-1P Dendrometer	0 to 10 mm	Mounted on implanted rod
	FI-LP Fruit Growth Sensor	30 to 160 mm	For rounded fruits
	FI-MP Fruit Growth Sensor	15 to 90 mm	For rounded fruits
	FI-SP Fruit Growth Sensor	7 to 45 mm	For rounded fruits
	FI-XSP Fruit Growth Sensor	4 to 30 mm	For rounded fruits
	LT-1P Leaf Temperature Sensor	0 to 50 °C	Based on a bead thermistor
	LT-IR Infrared Temperature Sensor	0 to 50 °C	Field of View: 3:1
	SF-4P Sap Flow Sensor	Approx. 12 ml/h max.	For 1 to 5 mm stem dia.
	SF-5P Sap Flow Sensor	Approx. 12 ml/h max.	For 4 to 10 mm stem dia.
	SA-20P Auxanometer	0 to 2000 mm	Draw-thread device
	LWS-02P Leaf Wetness Sensor	Dry/Wet status	Leaf simulator
	TIR-4P Pyranometer	0 to 1000 W/m ²	For solar radiation
	PIR-1P Quantum (PAR) Sensor (Photosynthetically active radiation)	0 to 2500 μmol m ⁻² s ⁻¹ ;	For solar radiation
	ST-21P Soil Temperature sensor	0 to 50 °C	11 cm long probe
	SMS-5P Soil Moisture sensor	0 to 100 vol. %	Calibrated for mineral soil, potting soil, and Rockwool
	SMTE Sensor: Soil Moisture, EC, and Soil Temperature	0 to 100 vol. % ; 0 to 15 dS/m; 0 to 50 °C	Integrated digital sensor. Calibrated for mineral soil, potting soil, and Rockwool
Each sensor has 4m cable to be connected to the PTM-48A Photosynthesis Monitor.			

Software installation

Insert the installation CD in your PC and follow on-screen instructions.

First start

Make sure that the PTM-48A and all available parts are connected according to the diagram on Page 6. In case your computer has no RS232 port, please use your own RS232/USB converter and configure it according to the manufacturer's instructions.

Switch the PTM-48A on. Run the PTM-48A program by clicking the PTM-48A icon located on the Desktop of your computer screen. You will see the following prompt window:

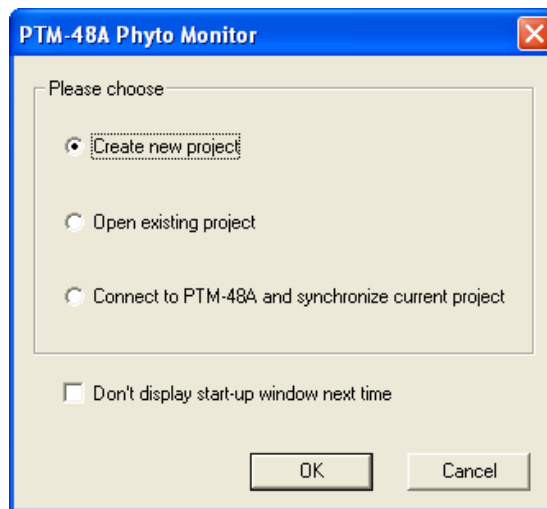

Select the Create new project option and click OK.

Notes:

- **Create new project** allows to create a completely new configuration of the data logging project.
 - **Open existing project** is used if you like to resume the data logging project created earlier. Do not choose this option in the first start.
 - **Connect to PM-48A and synchronize current project.** In some cases, the new PTM-48A may be supplied with the factory configuration that meets the customer's order. You may try to choose this option if you are sure that your configuration has been preset by your supplier. In such case, the project settings will be downloaded from the device memory.
2. In the **PTM-48A/Link setup** menu, you have to specify a COM port where the PTM-48A is connected to.

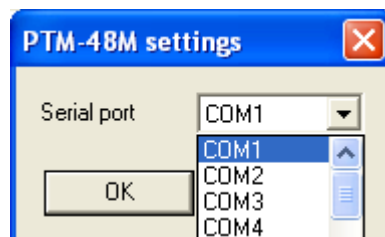

How to configure the data logging project

Click the **Project descriptor button** or choose the appropriate option from the **Project** menu. You will see the following window:

The screenshot shows the 'Project descriptor' window with the following fields and sections:

- Project:** LT-LC
- First record:** 04.01.1980 01:20
- Last record:** 30.04.2009 10:30
- Timing:**
 - Measurement time interval: 00:05:00 (hh:mm:ss)
 - Exact measurement time
- RTH:**
 - Radiation: RTH/R PAR
 - Soil type: Mineral Soil
- Sensors Table:**

In #	Sensor	Chamber	Notes
1	LT-LC # 2001	1	
2			
3			
4			
5			
6			
7			
8			
- Leaf Chamber Section:**

#	Leaf Chamber	Cover	LT-LC	Notes
1	LC-4B Standard Mode	1.00	1	
2		1.00		
3		1.00		
4		1.00		

Buttons: Clear All, OK, Cancel

- **Project** name shows either a specific name you gave to your project or automatically generated name, which includes year, month, date and time of the project start.
- **Timing** determines the measurement time interval. The recommended sampling time is 15 minutes for protected crops and 30 minutes for open-field crops.
- **Exact measurement time.** It is recommended to select this option that initiates measurements in rounded time. For instance, if you choose the 10 minutes sampling time at 10:06, the measurements will be done in 10:10, 10:20, 10:30 etc. If you uncheck this option, the measurement starts immediately and the measurement time will be 10:06, 10:16, 10:26, etc.
- **RTH** menu specifies some options for the RTH-48 Meter and SMTE (Soil moisture, temperature and EC sensor) if it is connected to the PTM-48A. The Radiation sensor shall be selected as RTH/R PAR. The Soil type determines the factory calibration for three available types of the soil: Mineral soil, Potting soil, and Rockwool. In case you would like to use your own calibration, please contact your dealer for requesting the appropriate instructions from the manufacturer.
- In the **Leaf Chamber** section, you may find three options. The *LC-4B Standard mode* is commonly recommended for the LC-4B Leaf Chamber. The standard measurement cycle is described on Page 11 of this Manual. The *LC-4B Extended mode* includes additional 30-sec long measurement of ambient CO₂ concentration at the end of measurement cycle of every leaf chamber. This mode is effective at slow fluctuations of ambient CO₂ concentration that may take place in controlled environment, in greenhouses for instance. However, this certainly makes the measurement cycle longer and, therefore, causes more rapid exhaust of CO₂ absorber. In case of using the LC-4D Opaque Leaf Chamber, you have to select the appropriate option. The **Cover** field is used in case the leaf is smaller than the leaf chamber window. In such case, the PTM-48A Monitor may automatically recalculate the exchange rates according to the evaluated coverage of the leaf chamber window. The entered percentage value is responsibility of the user. The **LT-LC** shows the input number where the LT-LC sensor for measuring leaf temperature inside a leaf chamber is connected to. In the **Notes** field, you may type any comment that relates two every particular leaf chamber.
- In the **Sensors** panel, you may configure the analog inputs of your PTM-48A Monitor. Please choose the appropriate sensor for every input where they are connected to. In case the LT-LC sensor is chosen, the **Chamber** field appears, and you have to select the input number of the leaf chamber where the LT-LC sensor is mounted. The appropriate number appears in the Leaf Chamber section under LT-LC header. In the **Notes** field, you may type any comment that relates two every particular sensor.

Start system operation in automatic mode

When the Project descriptor is completed, click OK button and click Yes in the window that appears:

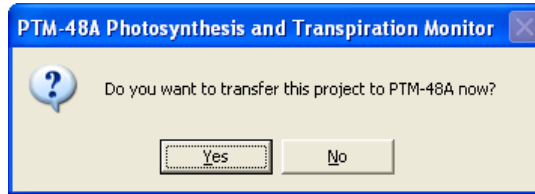

Now the project settings are transferred to the PTM-48A and, then, the Photosynthesis Monitor operates in automatic mode until the next intervention of the user.

How to view the recorded data

- In the **View/Control panel** menu, you may choose two options:
 - To view the **last (most recent) record** in the data base,
 - To see **current** of the sensors. The current readings are available only if the PTM-48A is on-line. The readings are updated every second on screen. No data are recorded in the data base. Leaf chambers do not operate in this mode.

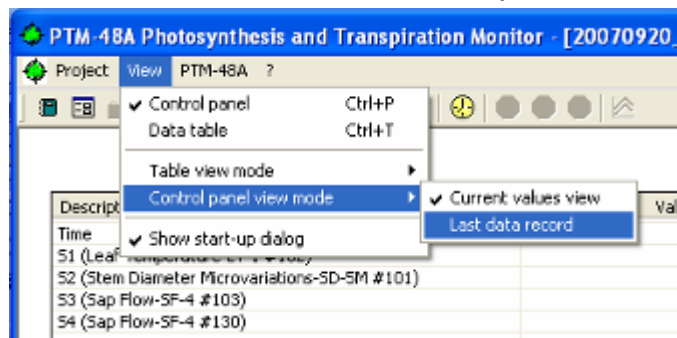

- In the **Data Table** view, you may see all records collected during the current data logging project.
- The **Table view mode** allows choosing the table format and selecting the data for viewing.

Start / Stop data logging

You may stop and resume the data logging session by using either appropriate commands in the **PTM-48A** menu or colored buttons in the toolbar:

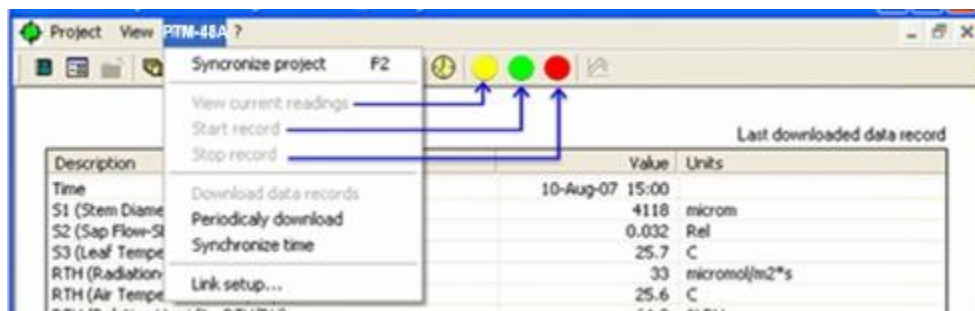

Sensors database

You may open the Sensors database from the **Project/Sensors database** command or by clicking the appropriate button in the toolbar.

The window contains a list of sensors which includes so-called Sample sensors which may be used for entering characteristics of all but most standard sensors available from the manufacturer. Below Sample sensors, there is a list of actual sensors that have been entered to the Database.

When selecting any sensor in the list, you may see all the data that relates to that particular sensor.

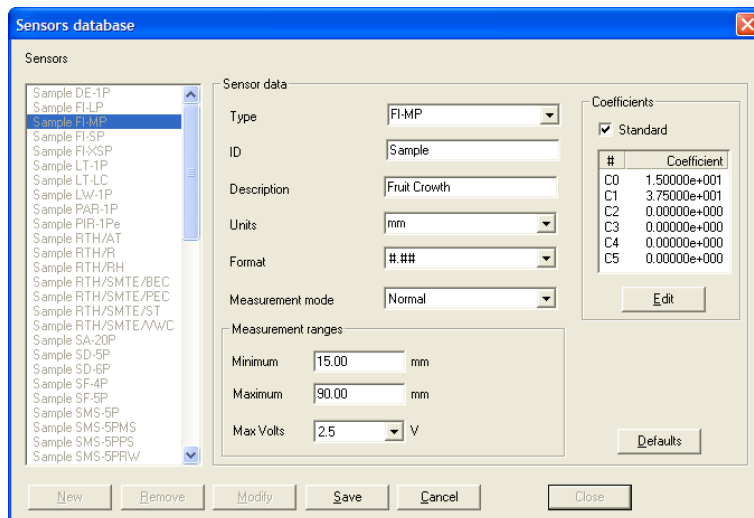

The user may enter a new sensor, and to modify allowable fields in the Sensor's data.

How to enter a new sensor

1. Click *New* button.
2. Select a sensor type.
3. Enter a serial number of the new sensor into the ID field.
4. For a non-standard sensor with individual calibration: enter coefficients from the datasheet enclosed with the sensor.
5. Click *Save* button.

Note: Please contact the manufacturer if you are not sure about the correct procedure and may need assistance.

Exporting the data in TXT or CSV format

Please choose the Project/Export menu for converting the data base into the TXT or CSV files.

- Valid data means that only the data that was recognize by the program as valid are converted.
- All data converts without exclusions.

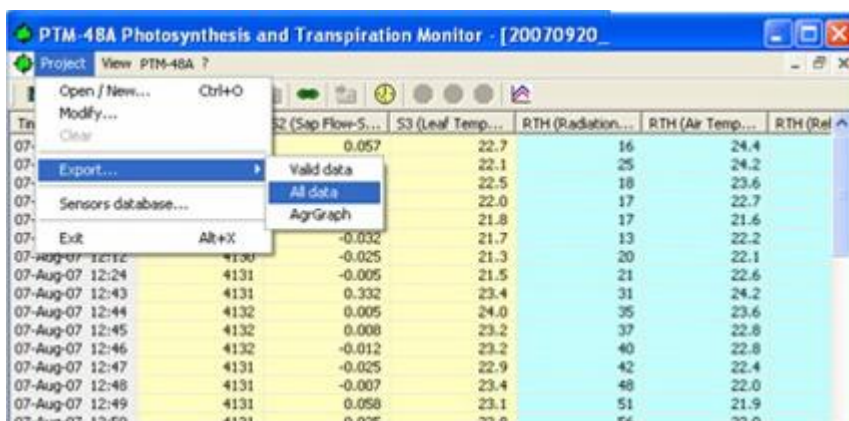

Principle of gas exchange measurement

The PTM-48A Photosynthesis Monitor is a four-channel automated system for monitoring CO₂ exchange and transpiration of leaves. The system is equipped with a set of four original self-clamping leaf chambers, which operate one-by-one in such a manner that one of the leaf chambers is closed at a time while all others remain open. Thus, most of time, the sample leaves are not disturbed that provides unique capability of continuous measurement, i.e. long-term monitoring.

The PTM-48A is an open photosynthesis measurement system so the CO₂ exchange is determined by decrement of CO₂ concentration at the outlet (C_{out}) of the leaf chamber, which is compared with the concentration of incoming ambient air (C_{in}). The CO₂ exchange rate E is calculated as follows:

$$E = k \times (C_{in} - C_{out}) \times F,$$





































where F is air flow rate and k is a dimension factor, which depends on air temperature and pressure and is calculated automatically by the system.

Transpiration rate is determined in much the same way as

$$Tr = (H_{out} - H_{in}) \times F,$$

where H is the absolute concentration of water vapor in the air. To shorten the measurement cycle, the H_{out} is computed during a transient period between 20th and 30th second after closing the chamber. The calculation algorithm also takes into account the rising humidity inside the chamber and, hence, allows determining the initial transpiration rate at the ambient air humidity.

The measurement sequence with four all leaf chambers is illustrated in the diagram below:

LC No.	Time scale of the measurement cycle in minutes									
	0 - 1.0	1.0 - 1.5	1.5-2.0	2.0 - 2.5	2.5 - 3.0	3.0 - 3.5	3.5 - 4.0	4.0-4.5	4.5 +	
1										Pause
2										
3										
4										
	All open Ch.1 to Analyzer Analyzer auto-calibration	Ch.1 closed and analyzed; All others open	All open Ch.2 to Analyzer	Ch.2 closed and analyzed; All others open	All open Ch.3 to Analyzer	Ch.3 closed and analyzed; All others open	All open Ch.4 to Analyzer	Ch.4 closed and analyzed; All others open	All open	

PTM-48A Photosynthesis Monitor • Advanced Information

The cycle starts from the chamber 1 connected to the analyzer channel. During first 30 seconds, the channel of the chamber 1 is purging. The reference concentration (C_{in}) is measured at the end of this stage. Chambers 2,3 and 4 are open and also purged at this stage by another separate section of the pump (see the pneumatic diagram below). Then, the Chamber 1 closes. This stage continues when C_{out} is reaching its steady-state value. At the end of 30-second measurement stage, the records for Chamber 1 are ready for further calculation of gas exchange rates. Then, the next chamber repeats both reference and measurement stages. If some optional sensors are connected to the system, their readings are collected at the beginning of the gas measurement cycle. Maximal duration of the operational cycle with 4 leaf chambers is about 4 minutes while each chamber is closed only 30 seconds. Typical (recommended) time interval between cycles is 30 minutes. Therefore, every leaf chamber is closed only during 1 minute in an hour when providing 48 measurements per day!

Pneumatic diagram of the system

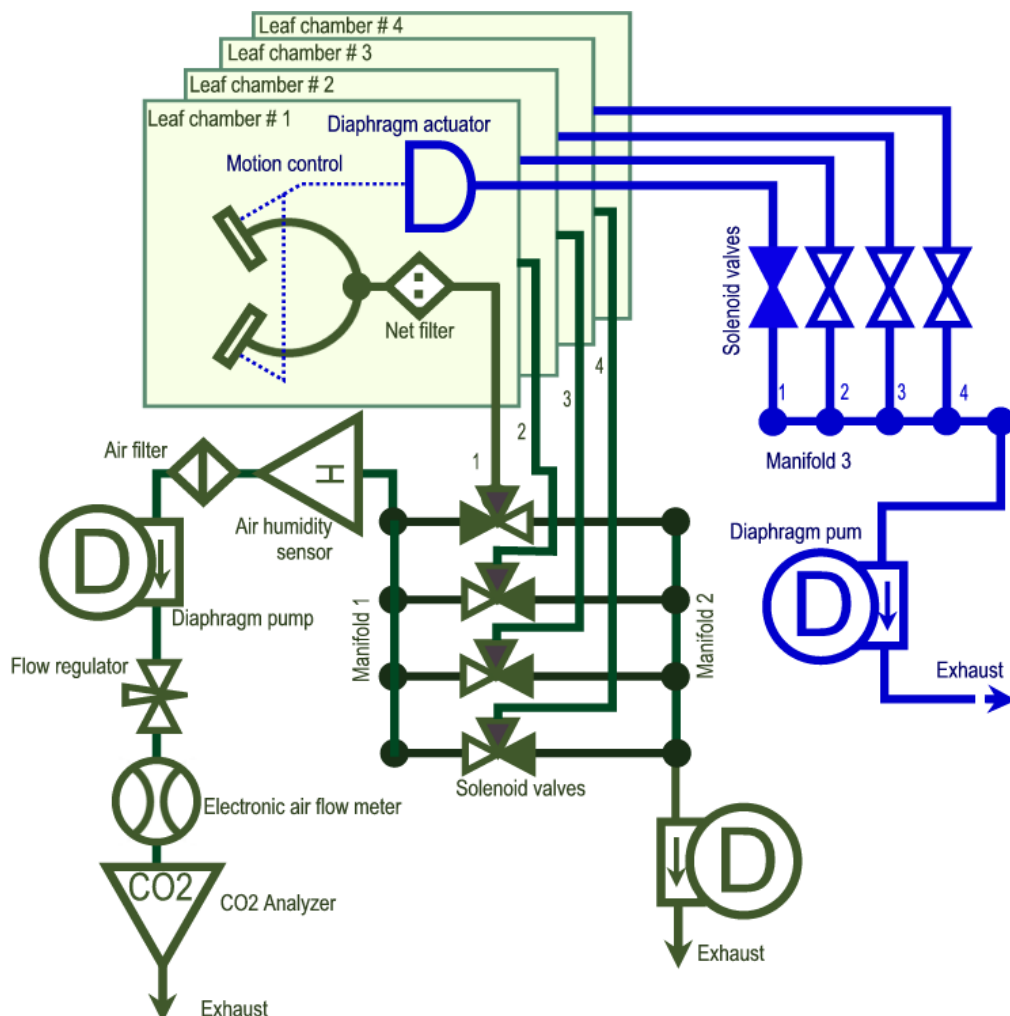

Stomatal conductance

The flux of water vapor (Tr) from the leaves can be expressed by the following equation proposed by Gaastra:

$$Tr = \frac{H_{leaf} - H_{atm}}{r_s + r_b}, \quad (1)$$

where H represent concentrations of water vapor, and their suffixes represent conditions at the surface of mesophyll cells (*leaf*) and in the bulk of atmosphere (*atm*). The resistances r to diffusion of water vapor are designated by suffixes '*b*' for boundary layer, and '*s*' for epidermis, comprising stomatal and cuticular resistance. Hence,

$$r_s = \frac{H_{leaf} - H_{atm}}{Tr} - r_b, \quad (2)$$

and $\sigma_s = \frac{1}{r_s}$, where σ_s represents stomatal conductance.

If to apply the Equation (2) to the LC-4B leaf chamber, one may conclude that Tr and H_{atm} are measured by the PTM-48A Monitor, r_b is a characteristic of the LC-4B leaf chamber and air flow rate in it, which has been found equal to 220 s/m. The value of H_{leaf} is actually a concentration of the saturated vapor at the leaf temperature, which can be measured by optional LT-LC sensor.

The LT-LC Leaf Temperature Sensor has a stainless steel wire clip for fixing on a leaf chamber. The miniature bead thermistor has good contact with the leaf due to oblong elastic plate. The thermistor's leads are positioned along a leaf surface to minimize effect on leaf temperature. The LT-LC sensor may be connected to any of eight optional analog inputs of the PTM-48A Photosynthesis Monitor.



When configuring the sensor in the PC program, the user shall specify input number of the leaf chamber equipped with the LT-LC sensor, and a relative coverage of the leaf chamber as described on Page 9.

Two new columns will appear in the data table of the leaf chamber: initial leaf temperature and stomatal conductance calculated as shown above.



Partitioning of the CO₂ Exchange

Illuminated leaves exhibit large transient CO₂ release when first exposed to darkness. This rapid increase is termed the respiratory post-illumination burst (PIB), followed by a second slower rise in respiration, which is termed light-enhanced-dark-respiration (LEDR). The first peak of post-illumination CO₂ release is usually considered as indication of photorespiration rate. The PIB technique may be easily realized in PTM-48A Monitor by using a leaf chamber with opaque window. Thus, by using a pair of leaf chambers, the regular transparent chamber and the opaque one, the Monitor may represent a full cycle of CO₂ exchange that allows a keen user to realize partitioning of the leaf CO₂ exchange.

The LC-4B Leaf chamber starts the measuring cycle, then, the opaque LC-4D chamber put the leaf to darkness. The typical record of the CO₂ Analyzer on C₃ plants is shown in the picture below:



LC-4D Leaf Chamber

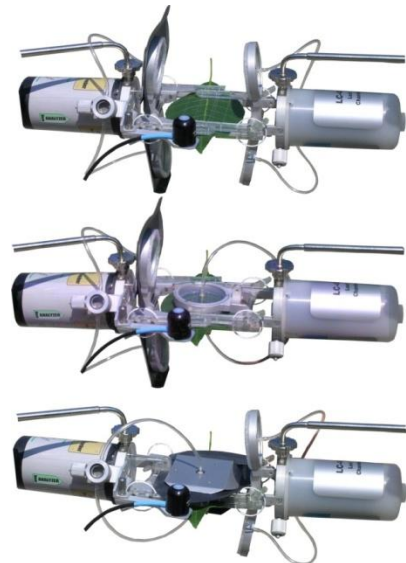
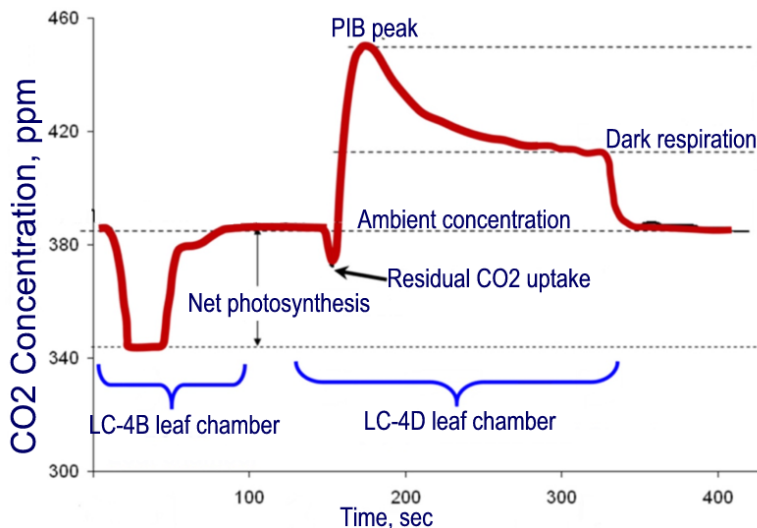

To perform the above-mentioned technique, the LC-4D Leaf Chamber should be better paired with the LC-4B chamber on the same leaf as shown in the picture above. However, they may be also placed alongside if the leaf is big enough, or on two adjacent similar leaves.

The rational connection to the PTM-48A Monitor is following: the LC-4B to air sampling inlets No. 1 and No.3; the LC-4D to air sampling inlets No. 2 and No.4. The air flow rate in the LC-4D shall be reduced to 0.4±0.1 LPM with the use of a special regulator supplied with the leaf chamber.

When the LC-4D is included in the Project, some new column appear in the data table. These are 'Real Assimilation', 'Total Respiration', 'Dark Respiration', and 'Photo Respiration'. Total Respiration corresponds to the PIB peak in the Figure above. Real Assimilation is a sum of Net Photosynthesis, measured by LC-4B, and Total Respiration. Photo Respiration is the difference between Total respiration and Dark respiration.

Specifications

Mode of operation	Continuous automatic
Number of leaf chambers	4
Sampling mode	Sequential from chamber 1 to 4.
Type of leaf chamber	Pneumatically powered, normally open
Leaf chamber aperture	20 cm ²
Sampling time for each leaf chamber	30 s
Standard hose length and inner diameter	4 m, ID=3.4 mm
CO ₂ measurement principle:	non-dispersive infrared analyzer
CO ₂ concentration measurement range	0-1000 ppm
Signal noise:	2 ppm pk-pk @ 350 ppm (with signal averaging)
H ₂ O measurement principle:	Integrated air temperature and humidity sensor
Air temperature measurement range	0 to 50 °C; Repeatability: ±0.1 °C
Air humidity measurement range	0 to 100% RH; Repeatability: ± 0.1% RH
Air flow measurement range	Range: 0.1 to 1.0 LPM; Accuracy: ± 0.02 LPM
Standard air flow rate in the leaf chamber	0.9 ± 0.1 LPM
Rated measurement range of CO ₂ exchange ¹	-40 to 40 μmolCO ₂ m ⁻² s ⁻¹
Overall error ²	0.95 μmolCO ₂ m ⁻² s ⁻¹ max.
Rated measurement range of H ₂ O exchange:	0 to 50 mgH ₂ O m ² s ⁻¹
Special-purpose digital inputs:	Input 1: For the integrated meter for measuring PAR, Air temperature, Air relative humidity, and wetness. Input 2: For the integrated sensor for measuring Soil temperature, moisture and EC.
Number of analog inputs for optional sensors	8 ³
Input range for optional analog sensors	From 0-1 Vdc to 0-10 Vdc programmable
Resolution of A/D converter	11 bit
Sampling rate:	Flexible, user-defined
Memory capacity ³ :	Over 1200 recorded lines
Power requirements	12 Vdc @ 60W max.
Communication options:	RS232 and RS485 (built-in), Wireless modem (optional)
Operating temperature range	10 to 40 °C
Environmental protection index	IP55
Gross weight with the package (complete set ⁴):	25 kg approx.

Notes: ¹The measurement range of 40 μmolCO₂m⁻²s⁻¹ corresponds to 130 ppm depletion of the CO₂ concentration in the leaf chamber. The reasonable depletion of 70 ppm corresponds to 20 μmolCO₂m⁻²s⁻¹

²Actual accuracy depends on the measured value. It varies from ±0.3 μmolCO₂m⁻²s⁻¹ at zero exchange to ±0.94 at 40 μmolCO₂m⁻²s⁻¹ exchange rate. The overall error *ERR* may be well represented (*R*²=0.975) by the following linear equation: *ERR* = 0.016 *E* + 0.26, where *E* is the measured photosynthesis rate.

³Every record line includes readings of all measuring units and sensors made at sampling time. Also it includes all computed values. At 30 minutes sampling time, the system may store the data during 25 days of operation.

⁴The complete set weight includes the systems console, four leaf chambers, hoses, tripods, fixing accessories, RTH-48 Meter, spare parts, and cases.

Maintenance

Objects of routine inspection

- 1) Airflow rate in sampling channel. Adjust if required.
- 2) Color of the absorber in the absorber column. This absorber should be replaced when it is two-thirds exhausted (brown).
- 3) Air filters clogging. Replace filter when required.
- 4) Transparency of leaf chamber windows. Clean when required by soft brush or tissue.

Failure to comply with these instructions may result in system malfunction.

Replacement of the CO₂ Absorber

First, carefully remove the absorber column by pulling it as shown in the picture on the right.

The next sections are quoted from the SBA-4 Operator's Manual (Version 1.0, ©2000 PPSystems, UK)



Absorber Column

We recommend monthly inspections of the absorber column foam pads, filter disks and "O" rings. Also check for cracks on the clear plastic column itself. The absorber column is fitted with 2 black end caps containing 2 white plastic disks, 2 "O" rings and 2 foam pads at each end. The black end fitting(s) can then be removed and the contents emptied when required. Columns are fitted with foam pads at each end to stop the contents spilling out if the ends are inadvertently pulled off during removal. When replacing the contents, the columns should be tapped to ensure tight packing and the foam replaced as found. The "O" rings on the end fittings should be occasionally lightly smeared with silicone grease to aid ease of fitting.

Take care when replacing the end fittings as the "O" rings can roll up and out of the groove. This will give rise to leaks and the SBA-4 will not work properly.

There can be a very tight fit between the tubes and end fittings. Pushing the end fittings on without proper care can cause the absorber column to crack. Again this will allow air to leak in and out of the column.

It is sensible to examine the absorber column each time the contents are replaced as any leakage of ambient air into the gas circuit generally causes errors during "Autozero" operation or fluctuating reference CO₂ concentration during measurement.

There are three items that should be checked after re-filling a column:

Absorber Column Foam Pads

The foam pads become worn over time and should be inspected regularly and replaced when torn or reduced in size. The foam must be open cell type, such as packing foam.

Absorber Column Filters

Each absorber column black end cap contains a white plastic filter disk. Generally these do not need to be replaced. However, they must be present to prevent any of the column contents being drawn with the gas stream into the instrument.

Absorber Column "O" Rings.

The "O" Rings on the end caps of the columns should be very lightly smeared with silicone grease to aid ease of fitting and improve the seal. Once sealed, end fittings should be checked to ensure that the O-rings are seated correctly in their groove and that they are not trapped or pinched.

There is also a small "O" ring on each of the absorber end cap fittings. These should be in good condition. Replacement "O" ring and filter sets can be ordered from PP Systems if required. See figure below for location of "O" rings and foam pads. The white plastic filter disks are located on the black end caps inside the absorber column.

Soda Lime

Soda Lime is supplied as self-indicating granules (1-2.5mm) which turn from green to brown as it becomes exhausted. This desiccant should be replaced when it is two-thirds exhausted (brown). Soda Lime cannot be regenerated and should be discarded when exhausted. Frequent replacement should not be required under normal circumstances. The amount of change is highly dependent on the "Auto-Zero" frequency and flow rate. Under normal operating conditions, this desiccant is changed approximately 1 time per month. For accurate measurements and calibration, it is absolutely critical that the SBA-4 absorber column is not exhausted. If the soda lime is becoming exhausted, it will cause the ZERO to be performed on non-ZERO air causing an error in the calibration.

! CAUTION !

**WASH YOUR HANDS AFTER HANDLING SODA LIME
MATERIAL SAFETY DATA FOR SODA LIME**

FIRST AID	
Inhalation	Remove from exposure. Obtain medical attention if discomfort persists.
Skin Contact	Drench with clean water. Obtain medical attention if skin becomes inflamed.
Eye Contact	Irrigate thoroughly with clean water. Obtain medical attention.
Ingestion	Wash out mouth thoroughly. Drink water. Obtain medical attention.
HAZARD LABELLING	
Transport Codes	None required.
Hazard Classification	None.

MATERIAL SAFETY DATA FOR SODA LIME

CHEMICAL COMPOSITION	
Components	% W/W
Calcium Hydroxide	(Ca(OH) ₂) > 75.5%
Sodium Hydroxide	(NaOH) < 3.5%
Water	< 21.0%
Indicator (Inorganic Salt)	< 0.2%
PHYSICO-CHEMICAL DATA	
Form	Granules
Color	Green (Exhausted : Brown)
Odor	None
Bulk Density	0.9 g/cm ³
Solubility in Water	None
pH in Water	12-14
Incompatible Substances	Acids, Chloroform, Trichloroethylene
Hazardous Decomposition	
Products	None
PROTECTIVE MEASURES, STORAGE AND HANDLING	
Storage Conditions	Clean dry environment
Preferred temperature range	0 - 35 °C. Store away from direct heat/sun.
Protective Measures	Avoid inhaling dust. Wash hands after handling
Industrial Hygiene	Keep containers closed. Keep contents dry.
MEASURES IN CASE OF ACCIDENTS AND FIRES	
Spillage	Contain material. Sweep or vacuum up. Transfer solids to metal or plastic container for disposal. Wash down spillage with water.
Suit. Extinguishing Media	Water, CO ₂ , Powder, Foam, Halon.

Leaf Chamber Filter



Check visually the state of the net filter. In case of clogging (dust, particles), go to the next step

Open a screw-top

Take out the net and remove foreign particles. Wash the net in the mild solvent if required.

Replace the net filter and the screw-top. Screw on tight!

Troubleshooting notes

Data records with asterisk

The data records made by the system are the result of complex series of pneumatic and electronic operations. The system has many automatic internal error checks, which screen bad data. Such data are automatically marked by asterisk (*) in the data table. The main conditions of bad data to be marked are following:

fluctuations of output signals exceed the following limits during last 10 seconds before recording: ± 5 ppm of CO₂ concentration, ± 0.05 g/m³ of air humidity, and ± 0.01 LPM of air flow rate.

Fluctuations of ambient CO₂ concentration

REMEMBER, THAT THE PM-48M PHOTOSYNTHESIS MONITOR IS AN OPEN-TYPE SYSTEM AND, THEREFORE, IT IS SENSITIVE TO FLUCTUATIONS OF CO₂ CONCENTRATION NEAR THE LEAF CHAMBERS. WE KNOW FROM OUR EXPERIENCE THAT THE HUMAN EXPIRATION IS THE MAIN SOURCE OF BAD DATA SO KEEP THE DISTANCE FROM THE WORKING LEAF CHAMBERS. REMOVE ALL POSSIBLE SOURCES OF CO₂ FROM THE EXPERIMENTAL AREA.

Automatic stop of the gas analysis system in wet conditions

The PTM-48A has a special algorithm for preventing ingress of water in the gas analysis system. Every time when the wetness sensor, which is connected to the RTH-48 Meter, detects water on its surface (due to rain, sprinkling, etc.) the pump stops and wait until the surface water disappears. Thus, the gas measurements are discontinued in wet conditions but the data logging of all electronic sensors still continues.

Alarms

There are some results of the internal automatic check that require the user to take necessary precautions. Please refer to the table below for troubleshooting:

	What happened	What the PTM-48A does	What to do?
Alarm indicator blinking	The gas analysis system is temporarily stopped because of wetness detected.	The PTM-48A stops measurements of gas exchange but still continues logging of sensors' data.	Nothing. Just make sure that wet conditions do take place and wait until wetness disappears.
	Air flow rate is out of the normal range, which is 0.9±0.1 LPM	The PTM-48A continues to work but marks all gas related records with asterisk (i.e. 'bad data').	Adjust the air flow rate to normal rate, i.e. 0.9±0.1 LPM.
	The aspiration fan in the RTH-48 fails	The PTM-48A continues to work but marks air temperature and humidity records with asterisk (i.e. 'bad data').	Repair the fan.
	Temperature inside the system console is out of acceptable range, i.e. below 0 or above 60 °C	The PTM-48A stops operation and wait until the temperature comes back into the acceptable range.	Check the possible causes of abnormal temperature. If it happened in hot weather conditions, shade the PTM-48A system console.
Alarm indicator blinks after the first cycle when the error occurred. It lights permanently after the second cycle with the error	Error in Gas Analyzer	The PTM transmits the error message of the Gas analyzer to computer. If the error took place during to sequential measurement cycles, it stops the gas related measurements.	Read the error message and take necessary measures.
Alarm indicator lights permanently	The central processor of the PTM-48A lost communication with any of its essential peripherals.	The PTM transmits the error message to the computer.	Check the possible causes of the problem. Consult the manufacturer if necessary.

If you use the 12 V battery as a power source of PTM-48A, the system may help you to monitor the battery charge as follows:

Alarm indicator blinking	The battery is almost flat.	The PTM transmits the appropriate message to the computer.	Replace or charge the battery.
Alarm indicator lights permanently	The battery is flat.	The PTM transmits the appropriate message to the computer. Operation of the PTM is stopped.	Replace or charge the battery.

Contact information

Contact Information for ordering CO₂ Absorber

PP Systems
241 Winter Street Unit 2, Glovers Court, Bury Mead Road
Haverhill, MA 01830 U.S.A.
Hitchin, Hertfordshire, SG5 1RT, U.K.
Tel: +1 978.374.1064 Tel: +44 (0) 1462.453411
Fax: +1 978.374.0972 Fax: +44 (0) 1462.431090
Email: support@ppsystems.com

PTM-48M Photosynthesis Monitor

Designed and engineered by Daletown Company Ltd.
Nicosia, P.O.Box: 28153, Post code 2091, Cyprus
Fax: +1 (661) 885 9369
E-mail: info@daletown-phyto.com

Assembled in Bio Instruments S.R.L.
P.O.Box 2250, Chisinau MD-2060, Republic of Moldova
Tel./Fax: +373-22-550026
E-mail: info@phyto-sensor.com
URL: www.phyto-sensor.com

Manufacturers of basic components used in the PTM-48A Photosynthesis Monitor

CO ₂ Analyzer	PP Systems 110 Haverhill Road, Suite 301, Amesbury, MA 01913, USA
Microcontroller	Rabbit Semiconductors 2900 Spafford Street, Davis, CA 95616-6800, USA
Air flow meter	Key Instruments 250 Andrews Road, Trevoise, PA 19053-3491 USA
Pneumatic valves and manifolds	Clippard Instrument Laboratory, Inc. 7390 Colerain Ave, Cincinnati OH 45239, USA
Air humidity sensor	Sensirion AG Eggbuehlstrasse 14, CH-8052 Zurich, Switzerland
Enclosures	Fibox Oy Ab P.O. Box 16, FIN-02421 Jorvas, Finland